

MO8921

High Frequency, -55°C to +125°C Oscillator



Features

- Frequencies between 119.342001 MHz and 137 MHz accurate to 6 decimal places
- Operating temperature from -55°C to +125°C
- Supply voltage of +1.8V or +2.5V to +3.3V
- Excellent total frequency stability as low as ±20 ppm
- Low power consumption of +4.9 mA typical at 20 MHz, +1.8V
- LVC MOS/LVTTL compatible output
- Industry-standard packages: 2.0 x 1.6, 2.5 x 2.0, 3.2 x 2.5, 5.0 x 3.2, 7.0 x 5.0 mm x mm
- Instant samples with Time Machine II and field programmable oscillators
- RoHS and REACH compliant, Pb-free, Halogen-free and Antimony-free

Applications

- Ruggedized equipment in harsh operating environment

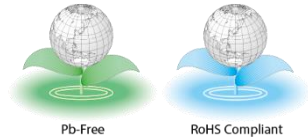

Electrical Specifications

Table 1. Electrical Characteristics

All Min and Max limits are specified over temperature and rated operating voltage with 15 pF output load unless otherwise stated. Typical values are at +25°C and nominal supply voltage.

Parameters	Symbol	Min.	Typ.	Max.	Unit	Condition
Frequency Range						
Output Frequency Range	f	119.342001	–	137	MHz	Refer to Table 13 for the exact list of supported frequencies
Frequency Stability and Aging						
Frequency Stability	F_stab	-20	–	+20	ppm	Inclusive of Initial tolerance at +25°C, 1st year aging at +25°C, and variations over operating temperature, rated power supply voltage and load (15 pF ± 10%).
		-25	–	+25	ppm	
		-30	–	+30	ppm	
		-50	–	+50	ppm	
Operating Temperature Range						
Operating Temperature Range	T_use	-55	–	+125	°C	
Supply Voltage and Current Consumption						
Supply Voltage	Vdd	+1.62	+1.8	+1.98	V	
		+2.25	+2.5	+2.75	V	
		+2.52	+2.8	+3.08	V	
		+2.7	+3.0	+3.3	V	
		+2.97	+3.3	+3.63	V	
		+2.25	–	+3.63	V	
Current Consumption	Idd	–	+6.2	+8.0	mA	No load condition, f = 125 MHz, Vdd = +2.8V, +3.0V or +3.3V
		–	+5.4	+7.0	mA	No load condition, f = 125 MHz, Vdd = +2.5V
		–	+4.9	+6.0	mA	No load condition, f = 125 MHz, Vdd = +1.8V
OE Disable Current	I_od	–	–	+4.7	mA	Vdd = +2.5V to +3.3V, OE = Low, Output in high Z state.
		–	–	+4.5	mA	Vdd = +1.8V, OE = Low, Output in high Z state.
Standby Current	I_std	–	+2.6	+8.5	µA	Vdd = +2.8V to +3.3V, \overline{ST} = Low, Output is weakly pulled down
		–	+1.4	+5.5	µA	Vdd = +2.5V, \overline{ST} = Low, Output is weakly pulled down
		–	+0.6	+4.0	µA	Vdd = +1.8V, \overline{ST} = Low, Output is weakly pulled down
LVC MOS Output Characteristics						
Duty Cycle	DC	45	–	55	%	All Vdds
Rise/Fall Time	Tr, Tf	–	1.0	2.0	ns	Vdd = +2.5V, +2.8V, +3.0V or +3.3V, 20% - 80%
		–	1.3	2.5	ns	Vdd = +1.8V, 20% - 80%
		–	1.0	3.0	ns	Vdd = +2.25V - 3.63V, 20% - 80%
Output High Voltage	VOH	90%	–	–	Vdd	IOH = -4.0 mA (Vdd = +3.0V or +3.3V) IOH = -3.0 mA (Vdd = +2.8V or +2.5V) IOH = -2.0 mA (Vdd = +1.8V)
Output Low Voltage	VOL	–	–	10%	Vdd	IOL = +4.0 mA (Vdd = +3.0V or +3.3V) IOL = +3.0 mA (Vdd = +2.8V or +2.5V) IOL = +2.0 mA (Vdd = +1.8V)

Table 1. Electrical Characteristics (continued)

Parameters	Symbol	Min.	Typ.	Max.	Unit	Condition
Input Characteristics						
Input High Voltage	V _{IH}	70%	–	–	V _{dd}	Pin 1, OE or \overline{ST}
Input Low Voltage	V _{IL}	–	–	30%	V _{dd}	Pin 1, OE or \overline{ST}
Input Pull-up Impedance	Z _{in}	50	87	150	kΩ	Pin 1, OE logic high or logic low, or \overline{ST} logic high
		2.0	–	–	MΩ	Pin 1, \overline{ST} logic low
Startup and Resume Timing						
Startup Time	T _{start}	–	–	5.0	ms	Measured from the time V _{dd} reaches its rated minimum value
Enable/Disable Time	T _{oe}	–	–	130	ns	f = 119.342001 MHz. For other frequencies, T _{oe} = 100 ns + 3 * clock periods
Resume Time	T _{resume}	–	–	5.0	ms	Measured from the time \overline{ST} pin crosses 50% threshold
Jitter						
RMS Period Jitter	T _{jitt}	–	1.6	2.5	ps	f = 125MHz, V _{dd} = +2.5V, +2.8V, +3.0V or +3.3V
		–	1.8	3.0	ps	f = 125MHz, V _{dd} = +1.8V
Peak-to-peak Period Jitter	T _{pk}	–	12	20	ps	f = 125MHz, V _{dd} = +2.5V, +2.8V, +3.0V or +3.3V
		–	14	25	ps	f = 125MHz, V _{dd} = +1.8V
RMS Phase Jitter (random)	T _{phj}	–	0.5	0.8	ps	f = 125MHz, Integration bandwidth = 900 kHz to 7.5 MHz
		–	1.3	2.0	ps	f = 125MHz, Integration bandwidth = 12 kHz to 20 MHz

Table 2. Pin Description

Pin	Symbol	Functionality
1	OE/ \overline{ST} /NC	Output Enable H ^[1] : specified frequency output L: output is high impedance. Only output driver is disabled.
		Standby H ^[1] : specified frequency output L: output is low (weak pull down). Device goes to sleep mode. Supply current reduces to I _{std} .
		No Connect Any voltage between 0 and V _{dd} or Open ^[1] : Specified frequency output. Pin 1 has no function.
2	GND	Power Electrical ground
3	OUT	Output Oscillator output
4	VDD	Power Power supply voltage ^[2]

Notes:

1. In OE or \overline{ST} mode, a pull-up resistor of 10kΩ or less is recommended if pin 1 is not externally driven. If pin 1 needs to be left floating, use the NC option.
2. A capacitor of value 0.1 μF or higher between V_{dd} and GND is required.

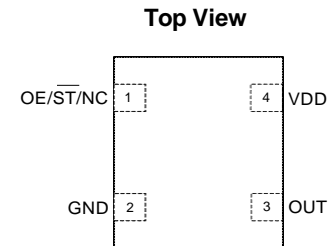

Figure 1. Pin Assignments

Table 3. Absolute Maximum Limits

Attempted operation outside the absolute maximum ratings of the part may cause permanent damage to the part. Actual performance of the IC is only guaranteed within the operational specifications, not at absolute maximum ratings.

Parameter	Min.	Max.	Unit
Storage Temperature	-65	+150	°C
Vdd	-0.5	+4.0	V
Electrostatic Discharge	–	+2000	V
Soldering Temperature (follow standard Pb free soldering guidelines)	–	+260	°C
Junction Temperature ^[3]	–	+150	°C

Note:

3. Exceeding this temperature for extended period of time may damage the device.

Table 4. Thermal Consideration^[4]

Package	θJA, 4 Layer Board (°C/W)	θJA, 2 Layer Board (°C/W)	θJC, Bottom (°C/W)
7050	142	273	30
5032	97	199	24
3225	109	212	27
2520	117	222	26
2016	152	252	36

Note:

4. Refer to JESD51 for θJA and θJC definitions, and reference layout used to determine the θJA and θJC values in the above table.

Table 5. Maximum Operating Junction Temperature^[5]

Max Operating Temperature (ambient)	Maximum Operating Junction Temperature
+125°C	+135°C

Note:

5. Datasheet specifications are not guaranteed if junction temperature exceeds the maximum operating junction temperature.

Table 6. Environmental Compliance

Parameter	Condition/Test Method
Mechanical Shock	MIL-STD-883F, Method2002
Mechanical Vibration	MIL-STD-883F, Method2007
Temperature Cycle	JESD22, Method A104
Solderability	MIL-STD-883F, Method2003
Moisture Sensitivity Level	MSL1 @ 260°C

Test Circuit and Waveform^[6]

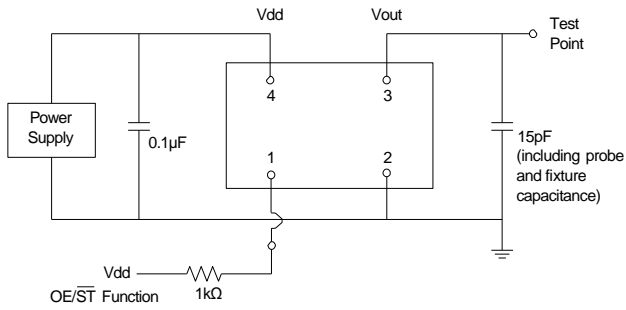

Figure 2. Test Circuit

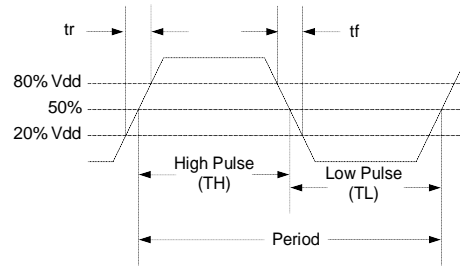
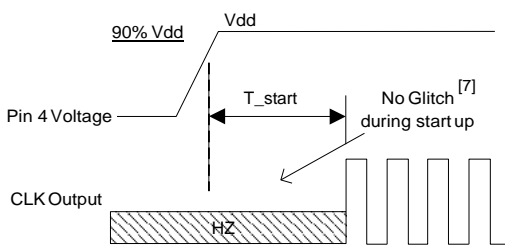

Figure 3. Waveform

Note:

6. Duty Cycle is computed as $Duty\ Cycle = TH/Period$.

Timing Diagrams



T_start: Time to start from power-off

Figure 4. Startup Timing (OE/ST Mode)

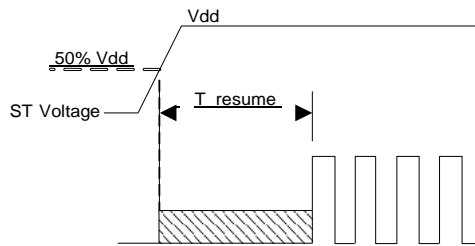

T_resume: Time to resume from ST

Figure 5. Standby Resume Timing (ST Mode Only)

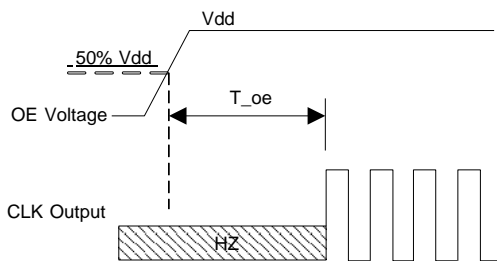

T_oe: Time to re-enable the clock output

Figure 6. OE Enable Timing (OE Mode Only)

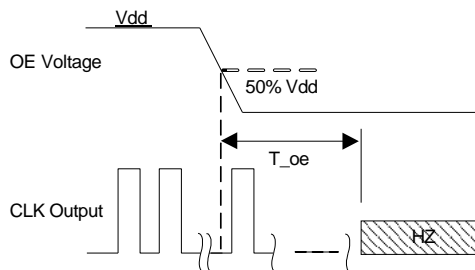

T_oe: Time to put the output in High Zmode

Figure 7. OE Disable Timing (OE Mode Only)

Note:

7. MO8921 has “no runt” pulses and “no glitch” output during startup or resume.

Performance Plots^[8]

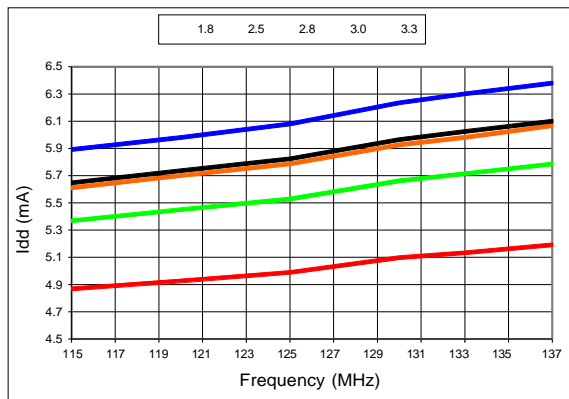

Figure 8. Idd vs Frequency

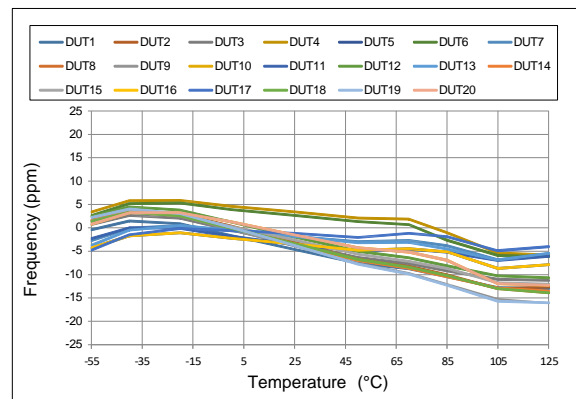

Figure 9. Frequency vs Temperature

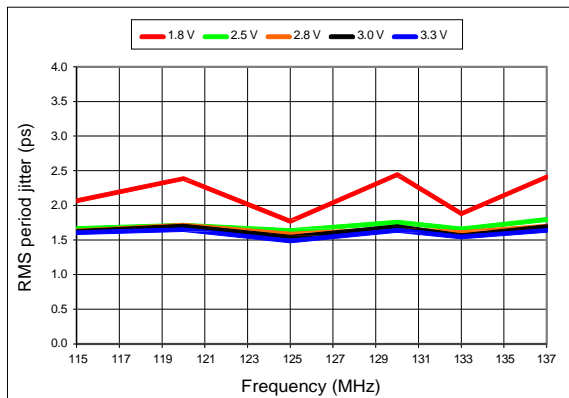

Figure 10. RMS Period Jitter vs Frequency

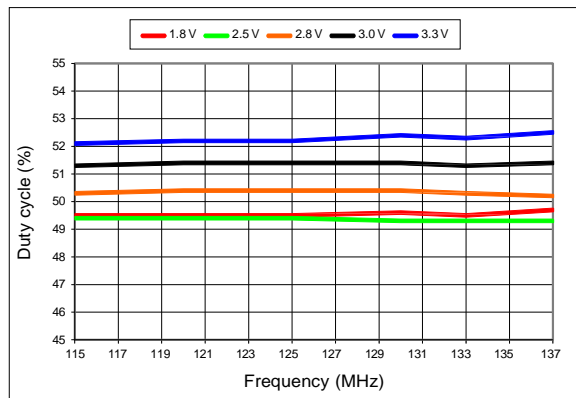

Figure 11. Duty Cycle vs Frequency

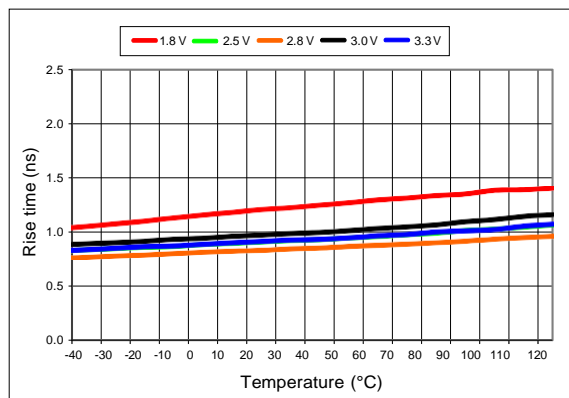

Figure 12. 20%-80% Rise Time vs Temperature (125 MHz Output)

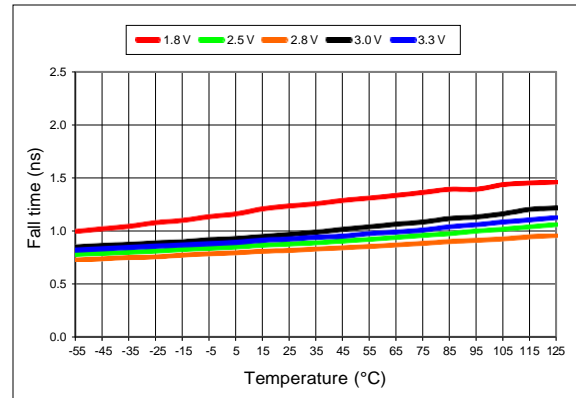

Figure 13. 20%-80% Fall Time vs Temperature (125 MHz Output)

Performance Plots^[8]

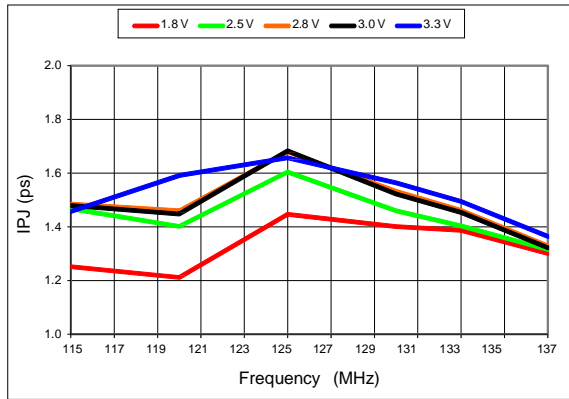

Figure 14. RMS Integrated Phase Jitter Random (12 kHz to 20 MHz) vs Frequency^[9]

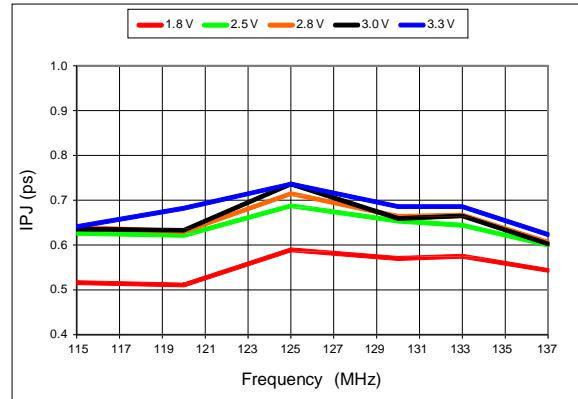

Figure 15. RMS Integrated Phase Jitter Random (900 kHz to 20 MHz) vs Frequency^[9]

Notes:

- 8. All plots are measured with 15 pF load at room temperature, unless otherwise stated.
- 9. Phase noise plots are measured with Agilent E5052B signal source analyzer.

Programmable Drive Strength

The MO8921 includes a programmable drive strength feature to provide a simple, flexible tool to optimize the clock rise/fall time for specific applications. Benefits from the programmable drive strength feature are:

- Improves system radiated electromagnetic interference (EMI) by slowing down the clock rise/fall time
- Improves the downstream clock receiver's (RX) jitter by decreasing (speeding up) the clock rise/fall time.
- Ability to drive large capacitive loads while maintaining full swing with sharp edge rates.

For more detailed information about rise/fall time control and drive strength selection, contact KDS.

EMI Reduction by Slowing Rise/Fall Time

Figure 16 shows the harmonic power reduction as the rise/fall times are increased (slowed down). The rise/fall times are expressed as a ratio of the clock period. For the ratio of 0.05, the signal is very close to a square wave. For the ratio of 0.45, the rise/fall times are very close to near-triangular waveform. These results, for example, show that the 11th clock harmonic can be reduced by 35 dB if the rise/fall edge is increased from 5% of the period to 45% of the period.

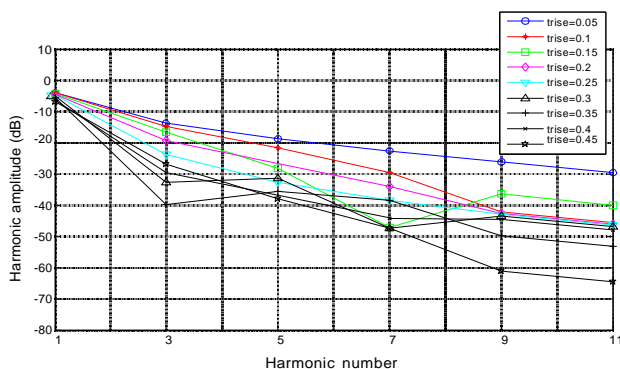

Figure 16. Harmonic EMI reduction as a Function of Slower Rise/Fall Time

Jitter Reduction with Faster Rise/Fall Time

Power supply noise can be a source of jitter for the downstream chipset. One way to reduce this jitter is to speed up the rise/fall time of the input clock. Some chipsets may also require faster rise/fall time in order to reduce their sensitivity to this type of jitter. Refer to the Rise/Fall Time Tables (Table 7 to Table 11) to determine the proper drive strength.

High Output Load Capability

The rise/fall time of the input clock varies as a function of the actual capacitive load the clock drives. At any given drive strength, the rise/fall time becomes slower as the output load increases. As an example, for a +3.3V MO8921 device with default drive strength setting, the typical rise/fall time is 0.46ns for 5 pF output load. The typical rise/fall time slows down to 1ns when the output load increases to 15 pF. One can choose to speed up the rise/fall time to 0.72ns by then increasing the drive strength setting on the MO8921 to "F".

The MO8921 can support up to 30 pF or higher in maximum capacitive loads with up to 3 additional drive strength settings. Refer to the Rise/Fall Time Tables (Table 7 to 11) to determine the proper drive strength for the desired combination of output load vs. rise/fall time

MO8921 Drive Strength Selection

Tables 7 through 11 define the rise/fall time for a given capacitive load and supply voltage.

1. Select the table that matches the MO8921 nominal supply voltage (+1.8V, +2.5V, +2.8V, +3.0V, +3.3V).
2. Select the capacitive load column that matches the application requirement (5 pF to 30 pF)
3. Under the capacitive load column, select the desired rise/fall times.
4. The left-most column represents the part number code for the corresponding drive strength.
5. Add the drive strength code to the part number for ordering purposes.

Calculating Maximum Frequency

Based on the rise and fall time data given in Tables 7 through 11, the maximum frequency the oscillator can operate with guaranteed full swing of the output voltage over temperature as follows:

$$\text{Max Frequency} = \frac{1}{5 \times \text{Trf}_{20/80}}$$

where Trf_{20/80} is the typical value for 20%-80% rise/fall time.

Example 1

Calculate f_{MAX} for the following condition:

- V_{dd} = +3.3V (Table 11)
- Capacitive Load: 30 pF
- Desired Tr/f time = 1.46 ns (rise/fall time part number code = E)

Part number for the above example:

MO8921MG4-CUH-33E0-0136986300



Drive strength code is here.

Rise/Fall Time (20% to 80%) vs C_{LOAD} Tables

Table 7. V_{dd} = +1.8V Rise/Fall Times for Specific C_{LOAD}

Rise/Fall Time Typ (ns)			
Drive Strength \ C _{LOAD}	5 pF	15 pF	30 pF
T	0.93	n/a	n/a
E	0.78	n/a	n/a
U	0.70	1.48	n/a
F or "0": default	0.65	1.30	n/a

Table 8. V_{dd} = +2.5V Rise/Fall Times for Specific C_{LOAD}

Rise/Fall Time Typ (ns)			
Drive Strength \ C _{LOAD}	5 pF	15 pF	30 pF
R	1.43	n/a	n/a
B	1.09	n/a	n/a
T	0.62	1.28	n/a
E	0.54	1.00	n/a
U or "0": default	0.43	0.96	n/a
F	0.34	0.88	n/a

Table 9. V_{dd} = +2.8V Rise/Fall Times for Specific C_{LOAD}

Rise/Fall Time Typ (ns)			
Drive Strength \ C _{LOAD}	5 pF	15 pF	30 pF
R	1.29	n/a	n/a
B	0.97	n/a	n/a
T	0.55	1.12	n/a
E	0.44	1.00	n/a
U or "0": default	0.34	0.88	n/a
F	0.29	0.81	1.48

Table 10. V_{dd} = +3.0V Rise/Fall Times for Specific C_{LOAD}

Rise/Fall Time Typ (ns)			
Drive Strength \ C _{LOAD}	5 pF	15 pF	30 pF
R	1.22	n/a	n/a
B	0.89	n/a	n/a
T or "0": default	0.51	1.00	n/a
E	0.38	0.92	n/a
U	0.30	0.83	n/a
F	0.27	0.76	1.39

Table 11. V_{dd} = +3.3V Rise/Fall Times for Specific C_{LOAD}

Rise/Fall Time Typ (ns)			
Drive Strength \ C _{LOAD}	5 pF	15 pF	30 pF
R	1.16	n/a	n/a
B	0.81	n/a	n/a
T or "0": default	0.46	1.00	n/a
E	0.33	0.87	n/a
U	0.38	0.79	1.46
F	0.25	0.72	1.31

Note:

10. "n/a" in Table 7 to Table 11 indicates that the resulting rise/fall time from the respective combination of the drive strength and output load does not provide rail-to-rail swing and is not available.

Pin 1 Configuration Options (OE, \overline{ST} , or NC)

Pin 1 of the MO8921 can be factory-programmed to support three modes: Output Enable (OE), standby (\overline{ST}) or No Connect (NC). These modes can also be programmed with the Time Machine using field programmable devices.

Output Enable (OE) Mode

In the OE mode, applying logic Low to the OE pin only disables the output driver and puts it in Hi-Z mode. The core of the device continues to operate normally. Power consumption is reduced due to the inactivity of the output. When the OE pin is pulled High, the output is typically enabled in $<1\mu\text{s}$.

Standby (\overline{ST}) Mode

In the \overline{ST} mode, a device enters into the standby mode when Pin 1 pulled Low. All internal circuits of the device are turned off. The current is reduced to a standby current, typically in the range of a few μA . When \overline{ST} is pulled High, the device goes through the “resume” process, which can take up to 5 ms.

No Connect (NC) Mode

In the NC mode, the device always operates in its normal mode and output the specified frequency regardless of the logic level on pin 1.

Table 12 below summarizes the key relevant parameters in the operation of the device in OE, \overline{ST} , or NC mode.

Table 12. OE vs. \overline{ST} vs. NC

	OE	\overline{ST}	NC
Active current 125 MHz (max, +1.8V)	+6.0 mA	+6.0 mA	+6.0 mA
OE disable current (max, +1.8V)	+4.5 mA	N/A	N/A
Standby current (typical +1.8V)	N/A	+0.6 μA	N/A
OE enable time at 125MHz (max)	130 ns	N/A	N/A
Resume time from standby (max, all frequency)	N/A	5.0 ms	N/A
Output driver in OE disable/standby mode	High Z	weak pull-down	N/A

Output on Startup and Resume

The MO8921 comes with gated output. Its clock output is accurate to the rated frequency stability within the first pulse from initial device startup or resume from the standby mode.

In addition, the MO8921 has no runt, no glitch output during startup or resume as shown in the waveform captures in Figure 17 and Figure 18.

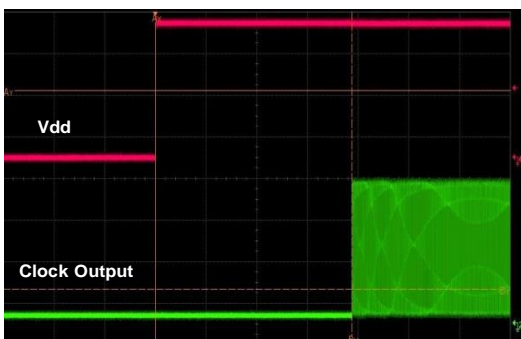

Figure 17. Startup Waveform vs. Vdd

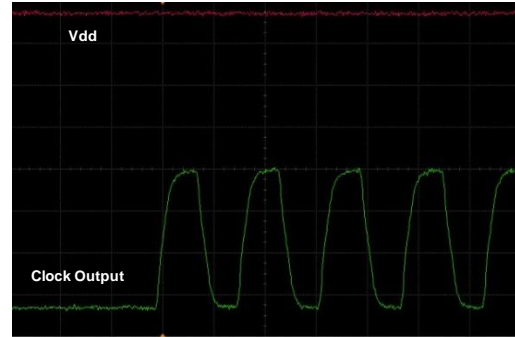

Figure 18. Startup Waveform vs. Vdd (Zoomed-in View of Figure 17)

Instant Samples with Time Machine and Field Programmable Oscillators

KDS supports a field programmable version of the MO8921 high temperature oscillator for fast prototyping and real time customization of features. The field programmable devices (FP devices) are available for all five standard MO8921 package sizes and can be configured to one’s exact specification using the Time Machine II, an USB powered MEMS oscillator programmer.

Customizable Features of the MO8921 FP Devices Include

- Frequencies between 119.3420001 – 137 MHz
- Four frequency stability options, ± 20 ppm, ± 25 ppm, ± 30 ppm, ± 50 ppm
- Six supply voltage options, +1.8V, +2.5V, +2.8V, +3.0V, +3.3V and +2.25 to +3.63V continuous
- Output drive strength

For more information regarding KDS’s field programmable solutions, contact KDS.

MO8921 is factory-programmed per customer ordering codes for volume delivery.

Dimensions and Patterns

Package Size – Dimensions (Unit: mm) ^[11]	Recommended Land Pattern (Unit: mm) ^[12]
<p>2.0 x 1.6 x 0.75 mm</p>	
<p>2.5 x 2.0 x 0.75 mm</p>	
<p>3.2 x 2.5 x 0.75 mm</p>	
<p>5.0 x 3.2 x 0.75 mm</p>	

Ordering Information

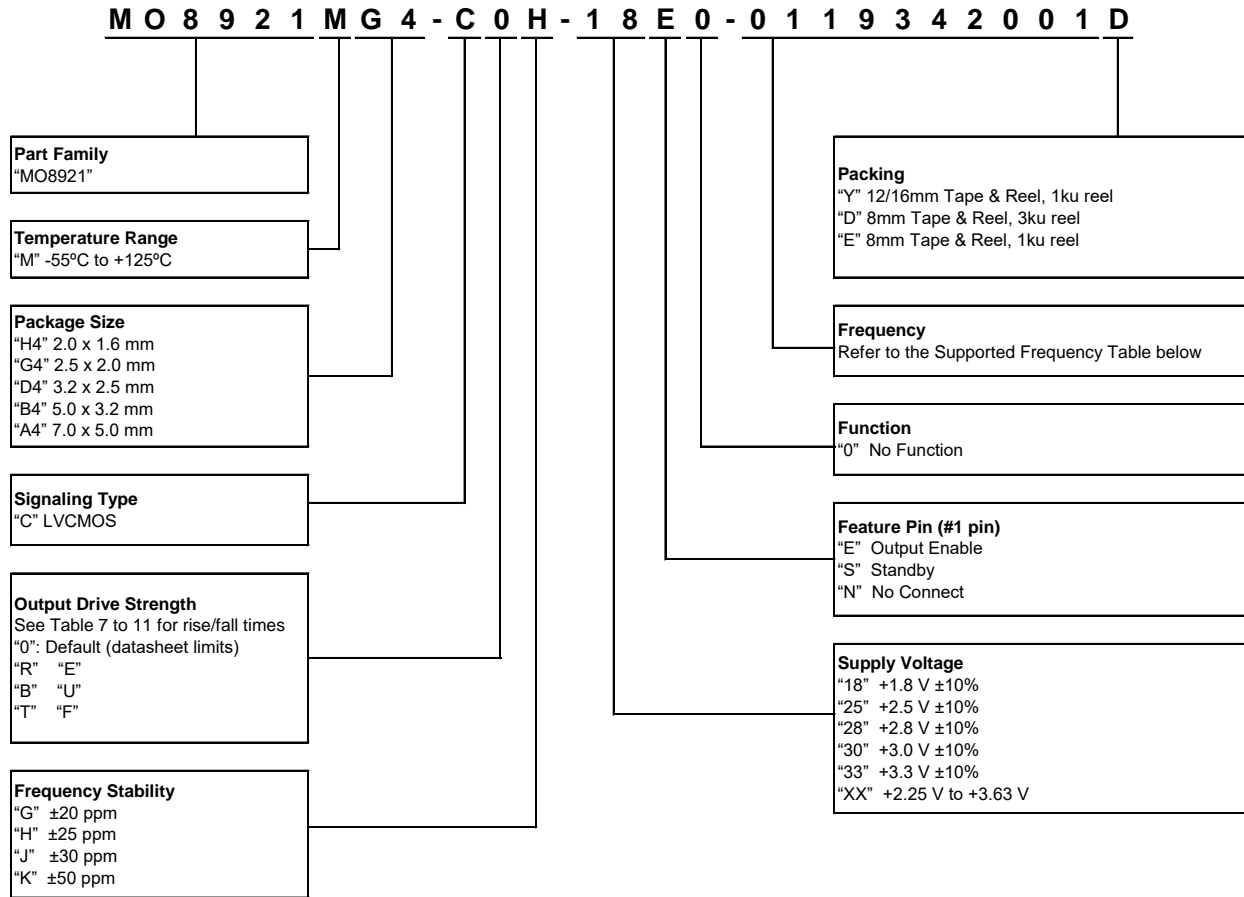

Table 13. List of Supported Frequencies^[13, 14]

Frequency Range (-55 to +125°C)	
Min.	Max.
119.342001 MHz	120.238999 MHz
120.262001 MHz	121.169999 MHz
121.243001 MHz	121.600999 MHz
123.948001 MHz	137.000000 MHz

Notes:

- 13. Any frequency within the min and max values in the above table are supported with 6 decimal places of accuracy.
- 14. Please contact KDS for frequencies that are not listed in the tables above.

Table 14. Ordering Codes for Supported Tape & Reel Packing Method

Device Size (mm x mm)	16 mm T&R (3ku)	16 mm T&R (1ku)	12 mm T&R (3ku)	12 mm T&R (1ku)	8 mm T&R (3ku)	8 mm T&R (1ku)
2.0 x 1.6	-	-	-	-	D	E
2.5 x 2.0	-	-	-	-	D	E
3.2 x 2.5	-	-	-	-	D	E
5.0 x 3.2	-	-	-	Y	-	-
7.0 x 5.0	-	Y	-	-	-	-

Revision History

Table 15. Datasheet Version and Change Log

Version	Release Date	Change Summary
1.0	5/7/15	Final production release
1.01	6/18/15	<ul style="list-style-type: none">• Added 16 mm T&R information to Table 14• Revised 12 mm T&R information to Table 14